



IJEAST

INTERNATIONAL JOURNAL
OF ENGINEERING APPLIED SCIENCE
AND TECHNOLOGY



VOLUME : 6 ISSUE : 5 Print / Issue Publication Date: 04-Dec-2021



ISSN : 2455-2143



DOI : 10.33564/IJEAST.2021.v06i05.053

Indexed In



WWW.IJEAST.COM

editor@ijeast.com

DESIGN OF HYDRAULIC ACTUATOR IN A TYPICAL AEROSPACE VEHICLE

Nishant P. Bagal, Kshitij D. Singh, Ashish S. Mishra
Student
Department of Mechanical
K.D.K.College of Engineering,
Nandanvan, Nagpur-440009, Maharashtra, India

Dr. A.V. Vanalkar
Assistant Professor
Department of Mechanical
K.D.K.College of Engineering,
Nandanvan, Nagpur-440009, Maharashtra, India

Abstract: - An Aerospace Vehicle is equipped for flight both inside and outside the reasonable air. An Actuation System is quite possibly the main Systems of an Aerospace vehicle. This paper study includes itemized investigation of different controls Actuation System and Design of an average Hydraulic Actuation Systems. An actuator control framework worried about electrical, electronic or electro mechanical. Actuator control frameworks may appear as incredibly straightforward, physically worked start-and-stop stations, or complex, programmable PC frameworks. Pressure driven Actuation System contains Electro Hydraulic Actuators, Servo Valves, Feedback Sensing components, Pump Motor bundle, Hydraulic Reservoir, Accumulator, different wellbeing valves, Filters and so on.

The main objective of this study involves design of Hydraulic Actuator and selection of various other components for the Actuation Systems of an Aerospace Vehicle. Plan of the framework incorporates plan of Hydraulic actuator and furthermore the Modeling and Analysis of actuator utilizing refined Software.

Keywords: - Actuation System, Aerospace Vehicle, Actuator, Servo Valves

I. INTRODUCTION

Hydrodynamics is a basic actuality in nature, you can't pack a fluid and you can pack a gas by higher pressing factor. However, how much pressing factor applies to a fluid into a framework and push on it toward one side, that pressing factor is sent through the fluid to the opposite finish of the framework. The pressing factor isn't decreased. Water driven siphon is utilized to produce water driven force by utilizing the motor force. Water driven force might be reconverted to mechanical force through the airplane. The different sorts of sending components are utilized to drive the mechanical connections to an ideal direction. They are Hydraulic, Pneumatic, Electrical AC Motor and Electrical DC Motor. Water driven framework utilizes 'oil' under tension and use

electro-water driven valve. Water powered actuators can create huge power/force to drive the controller joints without the utilization of decrease equipping. Electric engines with electrical enhancers and regulators and electrical stepper engine with reasonable hardware to control and interface. This is an additional benefit of the electric frameworks yet at the expense of expanded joint grating, electric framework yet at the expense of expanded joint rubbing, versatility and backfire, Pneumatic framework utilizes 'air' as the liquid medium with solenoid valve. These are hard to control precisely because of high erosion of seals and compressibility of air (or pneumatic medium). They are relatively cleaner than hydraulic systems.

A. Actuator

The pressure driven actuator comprises of chamber or liquid engine that utilizes pressure driven ability to work with mechanical activity. The mechanical movement gives a yield as far as direct, rotatory or oscillatory movement. As fluids are almost difficult to pack, a water driven actuator can apply an enormous power. The downside of this methodology is its restricted speed increase. The water driven chamber comprises of an empty round and hollow cylinder along which a cylinder can slide. The term single acting is utilized when the liquid pressing factor is applied to only one side of the cylinder. The cylinder can move just a single way, a spring being regularly used to give the cylinder a bring stroke back. The term twofold acting is utilized when pressing factor is applied on each side of the cylinder; any distinction in power between the different sides of the cylinder moves the cylinder aside or the other.



B. Main Components of actuator

- i Servo valves
- ii Cylinder
- iii LVDT

1) Actuator comprises of a Servo Jack and a Servo Valve. Servo Valve gives the necessary stream to move the straight actuator at determined speed. Jack comprises of piston& chamber and a straight potentiometer to give position Feedback. Servo valve (stream control valve) assumes a significant part in electro-water powered incitation framework. It comprises of a force engine stage and a water driven intensifier stage. Yield stream rate is relative to the information current.

2) LVDT



II. HYDRAULIC ACTUATION SYSTEM WORKIING

A typical Aerospace vehicle hydraulic actuation system consists of thrust vector control (TVC) system and aerodynamic control (ADC) system. TVC framework comprises of Boot lash water powered repository, a pressing factor alleviation valve, a non-return valve, a siphon engine bundle, 4 actuators, 11 hose gatherings (both pressing factor and return) hardened steel pipe congregations, pressure driven connectors and TVC linkage frameworks. ADC framework comprises of 4 actuators, 10 hose gatherings, an aggregator, 2 QC/DC areolas, SS pipe congregations, ADC linkage framework, and a charging valve.

Water driven actuators accomplish the gimbaling of the motor in TVC and development of the control surface in ADC. Each phase of the control scheme i.e. TVC and ADC is given a bunch of actuators. In the TVC stage, every motor is mounted with two actuators in commonly opposite ways (planes) for pitch and yaw. In ADC stage, every one of the four control surfaces is associated with an actuator. All out number of actuators in the vehicle is eight. The oil is stored in a bootstrap hydraulic reservoir, which supplies oil to the suction of the pump. The reservoir is self-pressurized piston type. It takes framework strain to foster a pull pressure. A variable conveyance hub cylinder type siphon driven by a DC compound engine, siphons the oil from supply at an evaluated framework pressure. The electrical supply to the motor is taken from a battery. High-pressure fluid is pumped through a nonreturn valve and a high-pressure filter. A high-pressure channel help valve is given in the pressing factor line. The

power source of the alleviation valve is associated with the bring line back. Two collectors are associated in line, up-stream to the actuators.

Gatherers supply request stream over the siphon stream and hose the pressing factor floods. The accumulators are charged with ultra-pure nitrogen. From every gatherer the stock is conveyed to four actuators. Electro-water powered actuators convert liquid pressing factor into movement in light of a sign. Return oil from all the eight actuators are passed through two low-pressure filters and fed-back to the reservoir. Two speedy associate couplings are given in the pressing factor and return line for interfacing outside rig.

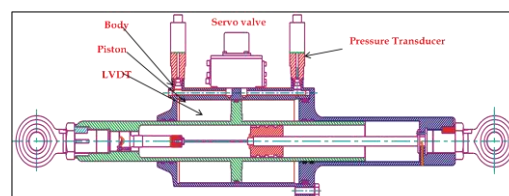
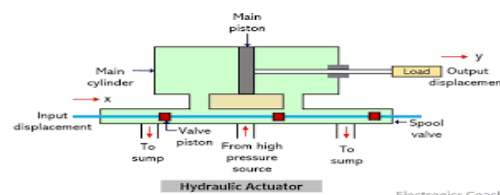

III. DESIGN OF ACTUATOR COMPONENTS

The significant burden bearing parts, which ought to be investigated for their solidarity. They are Piston, Body, Eye end.155Precipitation solidified hardened steel material is chosen for the manufacture of parts. Its principle advantage is its high strength with great mach failure. It is high corrosive resistant.

Design of Piston: -

For the plan of water driven chambers, speed and force should be determined in reliance of the current pressing factor in the chamber space and the volume stream accessible. For this, the permissible qualities for the working pressing factor in reliance of the pressing factor arrangement and the acceptable oil speed in the water powered ports should be considered.

	Single-rod cylinder $A_2 < A_1$	Double-rod cylinder $A_2 = A_1$
--	---	---

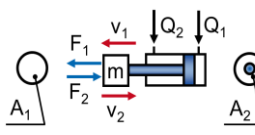
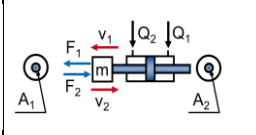
Calculati on formulae		
Working areas for extension	$A_1 = \frac{\pi}{4} \cdot D_k^2$	$A_1 = \frac{\pi}{4} \cdot (D_k^2 - d_s^2)$
Working area for retractin g	$A_2 = \frac{\pi}{4} \cdot (D_k^2 - d_s^2)$	$A_2 = \frac{\pi}{4} \cdot (D_k^2 - d_s^2)$
Power when extending	$F_1 = p \cdot A_1$	
Power when retractin g	$F_2 = p \cdot A_2$	
Flow rate for extension	$Q_1 = v_1 \cdot A_1$	
Flow rate for retractin g	$Q_2 = v_2 \cdot A_2$	

Formula symbol

- D_k Bore
- d_s Piston rod diameter
- p Pressure in cylinder
- A_1, A_2 Working areas of cylinder
- F_1, F_2 Force extending and force retracting of cylinder
- v_1, v_2 Travel speed
- Q_1, Q_2 Flow rate

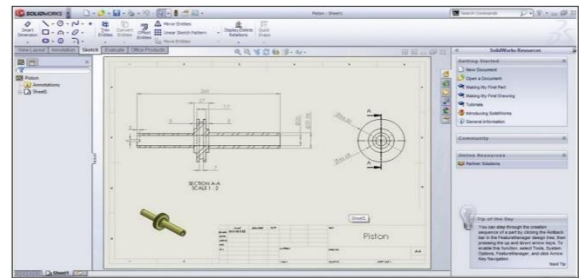

Design of Body: -

The body is shown in the fig. Below. Though it is having some extra material for mounting of the servo valve it is considered as a cylinder for the analysis purpose.

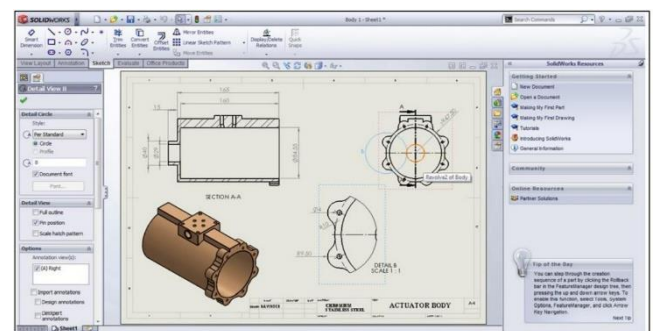

Design of Eye-End: -

This Eye end is making two functions. Acting as a head for hydraulic cylinder. Taking the direct load.

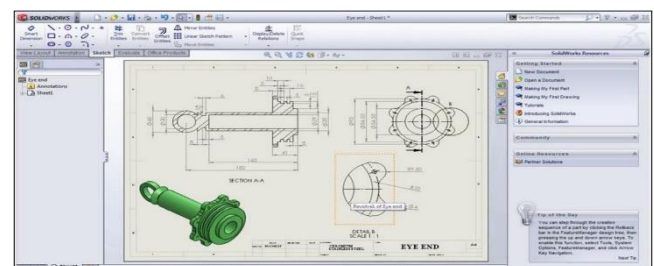

IV. RESULT

Thus, we studied about hydraulic actuators in this project.

V. CONCLUSION

The Hydraulic Actuators used in Aerospace Vehicle was based on static loads was designed and various components are modelled using sophisticated Solid Works Package. It is observed that the maximum Stresses, Strains and Displacements is obtained and the Components Piston, Body, Eye End, Bolt are Modelled.



Acknowledgement

Authors have great pleasure in expressing our most sincere regards and deep sense of gratitude to our Project Supervisor/Co-supervisor

Dr.A.V. Vanalkar for his able guidance and valuable suggestion.

Authors would like to express our deep sense of gratitude to our respected Dr. Chandrahas C. Handa Professor & Head, Department of Mechanical Engineering, K D K College of Engineering, Nagpur for his encouragement and support.

Authors feel happy to extend our heartfelt thanks to the Principal, Dr. D P Singh and Vice-Principal, Dr. A M Badar for being a source of inspiration & motivation.

Last but not least we would like to thank entire Mechanical Engineering Department, our parents and all our friends who have helped us in completing this task successfully.

Authors

1. Nishant P. Bagal
2. Kshitij D. Singh
3. Ashish S. Mishra
4. Dr.A. V. Vanalkar

VI. REFERENCES

1. www.solidworks.com
2. www.google.com
3. A textbook of "*Industrial Fluid Power*", by C.P. MURGUDKAR
4. A textbook of "*Fluid mechanics and hydraulic machines*", by Dr.R.K.Bansal, LAXMI PUBLICATION, 2012.
5. www.wikipedia.com

IJEAST

INTERNATIONAL JOURNAL
OF ENGINEERING APPLIED SCIENCE
AND TECHNOLOGY

ABOUT IJEAST

International Journal of Engineering Applied Science and Technology (IJEAST) is a peer-reviewed, open access journal that publishes high-quality research papers in the field of Engineering, Applied Science and Technology.

IJEAST aims to provide a platform for researchers, academicians, and professionals to share their innovative ideas, research findings, and practical experiences with the global scientific community.

FOCUS AREAS

- Engineering
- Applied Science
- Technology
- Innovation & Development
- Interdisciplinary Studies



PEER REVIEWED

All submissions are rigorously peer reviewed to ensure quality.



OPEN ACCESS

Free and unrestricted access to research for all.



GLOBAL REACH

Connecting researchers and professionals worldwide.



TIMELY PUBLICATION

We ensure a swift and efficient publication process.



For more information, visit our website

www.ijeast.com



INTERNATIONAL JOURNAL
OF ENGINEERING APPLIED SCIENCE
AND TECHNOLOGY

✉ editor@ijeast.com

🌐 www.ijeast.com

📍 India



2455-2143