



RENEWABLE ENERGY SYSTEM AND ITS NEEDS FOR ELECTRICAL ENERGY STORAGE SYSTEM

Ravi Bukya

Department of EEE
Malla Reddy College of Engg and Tech,
Hyderabad, Telangana, India

H. Ramesh

Department of EEE
Malla Reddy College of Engg and Tech
Hyderabad, Telangana, India

Abstract— The world is at a critical juncture in its pursuit of sustainable development, with the energy sector standing at the forefront of global challenges. India, as one of the fastest-growing economies and the second-most populous country, is undergoing a significant energy transition. The need for renewable energy resources has become increasingly evident against the backdrop of environmental concerns, economic imperatives, and a growing recognition of the finite nature of conventional energy sources. The global energy landscape has witnessed a paradigm shift in recent years, driven by an urgent need to address climate change and reduce dependence on finite fossil fuel resources. Countries around the world are acknowledging the imperative of transitioning towards cleaner and more sustainable energy alternatives. The Intergovernmental Panel on Climate Change (IPCC) underscores the urgency of limiting global warming to well below 2 degrees Celsius above pre-industrial levels, urging nations to adopt renewable energy sources as a pivotal component of mitigation strategies. The transition to renewable energy is not just a matter of choice; it is increasingly becoming a global imperative for ensuring the well-being of current and future generations.

Against this global backdrop, India grapples with its own unique energy challenges. As of the last available data up to January 2022, India remains heavily reliant on conventional energy sources, with coal, oil, and natural gas comprising the bulk of its energy mix. While these sources have fueled the country's impressive economic growth, they have also contributed significantly to environmental degradation, including air pollution, water contamination, and heightened greenhouse gas emissions. The pursuit of economic development must now be balanced with the imperative to transition to sustainable and

environmentally friendly energy sources. Table.1 shows the total installed generation capacity in India

Keywords— Fast charging, static, dynamic, wireless charging system, Electric Vehicle.

I. INTRODUCTION

Renewable energy integration aims to broaden the spectrum of energy sources, mitigating dependence on fossil fuels and enhancing the resilience of power systems. However, challenges arise concerning the consistency and availability of renewable sources. Regardless of the source, a balance between the electricity fed into the grid and the amount withdrawn is crucial to prevent power outages. Unlike renewable sources like water and geothermal, which can provide a consistent baseload of power, options like wind and solar exhibit significant variations throughout the day and across seasons. While some regions may find certain renewable sources impractical, others may benefit from their potential.

The seamless integration of renewable energy into power grids is essential for efficient generation, transmission, and distribution of electricity to end consumers. This integration hinges on grid optimization technologies, encompassing advanced sensors, automation, and real-time data analytics. These technologies play a pivotal role in maintaining a stable and reliable energy supply.

Ultimately, the success of renewable energy integration relies on intelligent technologies that optimize energy distribution and enhance the efficiency of grid management. By navigating the complexities of variable renewable sources, these technologies contribute to a sustainable and resilient energy landscape. The objectives of renewable energy integration are given below.

Grid integration entails the strategic development of effective methods for incorporating substantial levels of variable Renewable Energy (RE) into the power grid [1].

Its primary objectives encompass ensuring a dependable electricity supply through the utilization of diverse energy sources, facilitating power exchange between distinct electrical

subsystems, and meeting power demand in accordance with load requirements.

The integration process also seeks to fulfill specific subsystem requirements, such as adhering to prescribed frequency, voltage magnitude, power factor, and the velocity in rotating machinery.

Furthermore, grid integration strives to enhance the stability, power quality, and overall reliability of power supply sources.

A key aspect of this practice is the maintenance of power quality both at utility levels and at the customer end. By achieving these objectives, grid integration plays a crucial role in creating a resilient, sustainable, and efficient energy system that accommodates the variability inherent in renewable energy sources.

II. NEED OF RENEWABLE ENERGY INTERCONNECTIONS

Distinguishing between grid-feed inverters and grid-interactive inverters unveils key disparities in their functionalities and capabilities within solar photovoltaic (PV) systems.

A. Grid-Feed Inverters

Grid-feed inverters follow a straightforward mechanism by channeling power directly from solar PV panels to the grid. This unidirectional flow ensures a seamless injection of solar-generated electricity into the grid infrastructure.

B. Grid-Interactive Inverters

In contrast, grid-interactive inverters not only fulfill the role of grid-feed inverters but introduce a two-way power flow dynamic. Beyond feeding excess energy into the grid, they have the capacity to draw power back, effectively functioning as bidirectional energy conduits. A distinctive feature of grid-interactive inverters is their incorporation of a battery bank along with an automatic built-in charger.

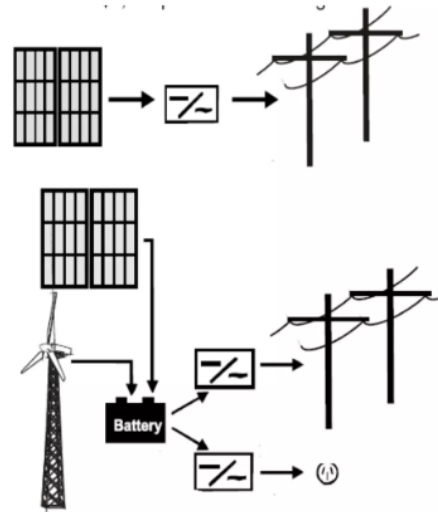

Fig. 1a)Grid-Interactive Inverters b) Grid-Feed Inverters

1.3.3 The Imperative for Grid-Interactive Converters in Modern Energy Systems

The contemporary energy landscape is undergoing a transformative shift, driven by the increasing integration of renewable energy sources. As the world endeavors to transition towards a more sustainable and environmentally conscious energy paradigm, the role of grid-interactive converters emerges as a critical component in achieving a resilient and efficient power grid. This introduction delves into the multifaceted need for grid-interactive converters, exploring their significance in addressing challenges posed by the variability and intermittency inherent in renewable energy sources.

Grid-interactive converters, often synonymous with inverters or power electronic devices, play a pivotal role in connecting renewable energy systems to the electrical grid. These devices facilitate the seamless exchange of energy between distributed renewable sources, such as solar panels and wind turbines, and the centralized power grid. Their versatility lies in their ability to convert the direct current (DC) generated by these sources into alternating current (AC) compatible with the grid, thereby enabling a harmonious integration of renewable energy into the existing infrastructure. The Objectives of Grid Interactive converters are Given as

1. **Enhancing Grid Resilience:** One of the primary imperatives driving the need for grid-interactive converters is the enhancement of grid resilience. The variable nature of renewable energy sources, such as solar and wind, poses challenges to grid stability. Grid-interactive converters serve as intermediaries, smoothing the integration of intermittent energy flows



into the grid and contributing to a more robust and resilient power infrastructure.

2. **Mitigating Intermittency Challenges:** Renewable energy sources are inherently intermittent, dependent on factors like weather conditions and time of day. Grid-interactive converters act as intelligent controllers, managing the fluctuations in energy output and mitigating the challenges associated with intermittent power generation. This functionality is crucial for maintaining a consistent and reliable power supply to meet the demands of consumers.

3. **Optimizing Energy Harvesting:** Grid-interactive converters play a pivotal role in optimizing energy harvesting from renewable sources. By efficiently converting DC power to AC power, these devices ensure that the maximum available energy from solar panels or wind turbines is harnessed and injected into the grid. This optimization is integral to maximizing the economic viability and sustainability of renewable energy systems.

4. **Enabling Grid Support Functions:** Beyond their primary role in facilitating energy exchange, grid-interactive converters contribute to grid support functions. They can provide ancillary services such as frequency regulation, voltage control, and grid synchronization. This multifunctionality enhances the stability and reliability of the grid, making it more adaptable to the evolving energy landscape.

5. **Promoting Distributed Energy Resources (DERs):** The global trend towards decentralized energy generation is driving the need for effective integration of distributed energy resources. Grid-interactive converters enable the seamless connection of DERs to the grid, fostering a more decentralized and resilient energy system. This decentralization contributes to energy security and reduces dependence on centralized power plants.

Types of batteries can mainly be classified as Primary and Secondary batteries. A Battery refers to a device having one or more electrical cells that convert chemical energy into electrical. Redox Reactions between the two electrodes take place in every battery and act as the source of the chemical energy. On the basis of their applications, the batteries can be classified as household batteries, industrial batteries, and vehicle batteries.

What is a battery ?

A battery is a device that is used to convert chemical energy into electrical energy by using one or more electrical cells.

Charged ions pass through an electrolyte solution in contact with both electrodes of the batteries to balance the flow of electrons.

Different electrodes and electrolytes are the ones that cause different chemical reactions in the battery, impacting how it

works, how much energy it can store, and how much voltage it can produce.

A functional battery must have the following characteristics: It must be light in weight and tiny in size.

A consistent voltage must be provided by the cell or battery. Furthermore, the battery or cell's voltage must not alter while in use.

Types of Batteries

Batteries are basically categories into two categories:

Primary batteries/cells Secondary batteries/cells Other common types of batteries on the basis of their application are as follows –

Household Batteries: These types of batteries are used in a wide range of household appliances such as clocks, torches, and cameras. These batteries are further classified as:

Rechargeable batteries – Examples: Lithium-Ion and Cadmium batteries

Non-rechargeable batteries – Examples: Silver oxide, Alkaline & carbon-zinc batteries

Industrial Batteries

These batteries are used as backup power for big companies. Some examples of industrial batteries are Nickel Iron and Wet Nickel Cadmium (NiCd).

Vehicle Batteries

These types of batteries are user-friendly and less complicated than industrial batteries. They are designed to power boats, cars, motorcycles, and other vehicles. Example – Lead-acid battery.

Primary Battery

The primary batteries are designed to be used only once and are non-rechargeable. As the devices are not easily reversible, and active materials may not return to their original forms, these types of batteries cannot be recharged once they have been used.

The common AA and AAA batteries found in wall clocks, television remotes, and other electrical devices are examples of these disposable batteries.

Primary cells include the Daniell cell, Dry cell, and Mercury cell.

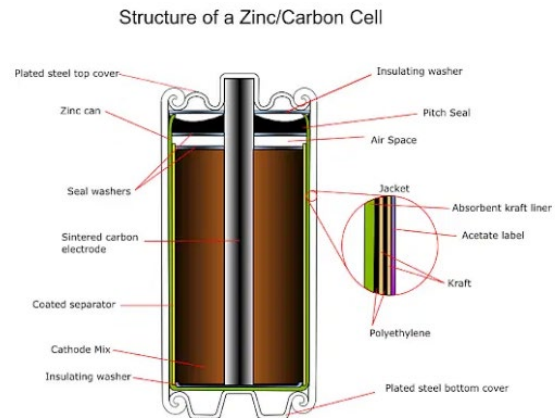
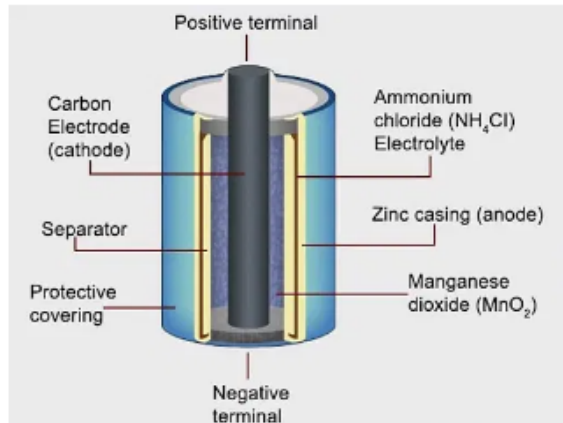

Primary Cell

Types of Primary Batteries

There are mainly two types of primary batteries.

Alkaline Batteries

Coin Cells Battery

1. Alkaline Batteries

In the 1950s, alkaline batteries were created to overcome some of the performance concerns with zinc-carbon dry cells. They're made to be exact substitutes for zinc-carbon dry cells. Alkaline electrolytes, such as potassium **hydroxide**, are used in these batteries.

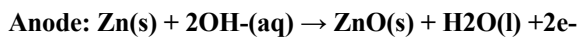

$$E^\circ \text{ anode} = -1.28\text{V}$$

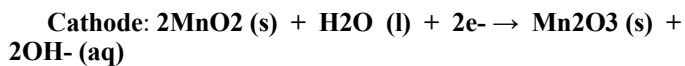

$$E^\circ \text{ cathode} = +0.15\text{V}$$

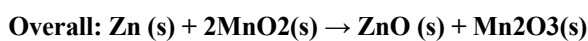

$$E^\circ \text{ cell} = +1.43\text{V}$$

Zinc Carbon Cell

A zinc-carbon dry cell of comparable size can offer three to five times the energy of an alkaline battery. Alkaline batteries are prone to leaking potassium hydroxide, so they should be removed from devices before being stored for long periods.

2. Coin Cells Battery

Coin cell batteries contain alkaline electrolytes as well as lithium and silver oxide compounds. These primary batteries are extremely effective at maintaining a constant and stable voltage.



Coin cell battery

Secondary Battery

Secondary batteries are sometimes known as rechargeable batteries. These types of batteries can be utilized while also being recharged.

Secondary batteries are usually made up of active ingredients that are released after use.

Rechargeable batteries are recharged with electric current, which reverses the chemical reactions that occur during discharge.

Chargers are electronic devices that supply the required current.

Rechargeable batteries include those found in cell phones, MP3 players, and other electronic gadgets.

Hearing aids and wristwatches generally need small batteries, as compared to phone exchanges and computer data centres which use larger batteries.

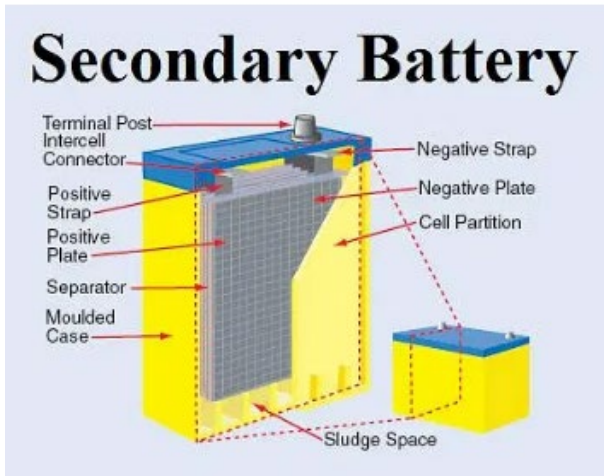

Secondary Battery

Types of Secondary Battery

The types of secondary batteries are as follows –

Lead – Acid Batteries

Lead-Acid batteries are by far the most popular and widely used rechargeable types of batteries. Small, sealed cells with a capacity of 1 Ah to huge, sealed cells with a capacity of 12,000 Ah are all available in lead-acid batteries. Lead-acid batteries are widely employed in the automobile industry, where they are typically used as SLI Batteries (Starting, Lighting, and Ignition). Other uses for lead-acid batteries include,

- Energy storage
- Backup power
- Electric cars (including hybrids)
- Communication systems
- Emergency lighting

Nickel – Cadmium Batteries

Along with lead-acid batteries, Nickel – Cadmium Batteries, or simply Ni-Cd Batteries, are some of the oldest batteries accessible today. They have a lengthy lifespan and are extremely dependable and durable.

Ni-Cd batteries can withstand high discharge rates and function over a wide temperature range, which is one of its key advantages.

Ni-Cd batteries also have a very long shelf life.

On a per Watt-hour basis, these batteries are more expensive than lead-acid batteries, but they are less expensive than other types of alkaline batteries.

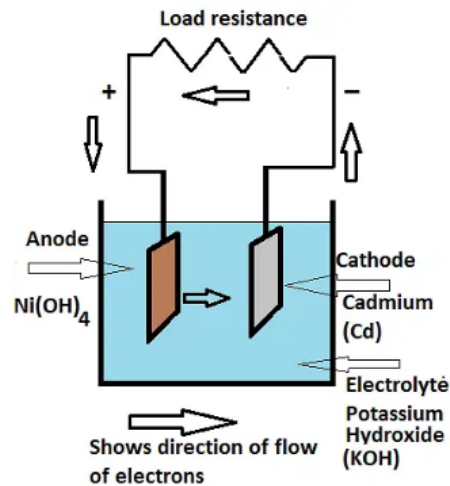

Nickel Cadmium Battery

Nickel–Metal Hydride Batteries

These types batteries are an advanced variant of nickel-hydrogen electrode batteries, which were previously only utilized in aerospace applications (satellites).

Nickel Oxyhydroxide (NiOOH) serves as the positive electrode, while a metal alloy serves as the negative electrode, where hydrogen is stored reversibly. Nickel-metal hydride batteries have a higher specific energy and energy density than Ni-Cd batteries, which is one of their key advantages. Small cylindrical sealed nickel-metal hydride batteries are commercially available and are utilized in portable electronics.

Lithium-Ion Batteries

The development of lithium-ion batteries has been amazing in the previous few decades. Lithium-ion batteries have been embraced by more than half of the consumer market.

Laptops, mobile phones, cameras, and other electronic devices are among the most common uses for lithium-ion batteries.

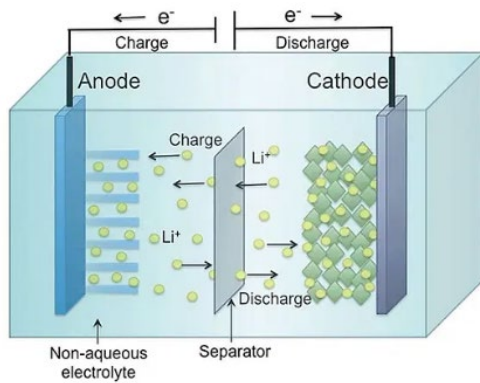

Lithium-Ion Batteries

How does a battery work?

A battery is a device that consists of several voltaic cells. A conductive electrolyte comprising anions and cations connects two half-cells in series to form a voltaic cell. The electrolyte and the electrode to which anions migrate, the anode or negative electrode, are in one half of the cell, while the electrolyte and the electrode to which cations move, the **cathode** or positive electrode, are in the other.

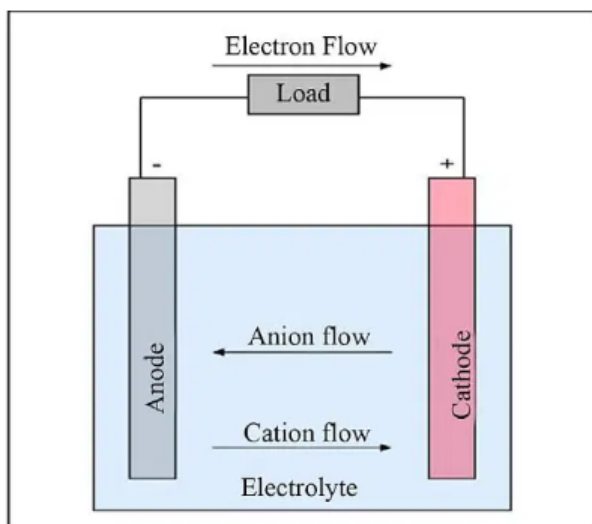

Working of a Battery

Cations are reduced at the cathode and anions are oxidized at the anode in the redox reaction that drives the battery. The electrodes are not in direct contact with one another, but the electrolyte connects them electrically. In most cases, the electrolytes in the half cells are different. Each half-cell is housed in a container, and mixing is prevented by a separator that is permeable to ions but not to the bulk of the electrolytes.

Uses of Battery

Batteries are utilized in a variety of ways. Below are some of the applications:

Domestic uses

Disposable batteries are used to power goods such as remote controls, flashlights, and other similar devices. Digital cameras, handheld video game consoles, telephones, and a range of other devices, for example, require alkaline batteries. Advanced batteries, such as lithium batteries, are used to power high-power appliances like laptops and other electronics.

Medical Applications

Artificial limbs, hearing aids, insulin pumps, and valve support devices all need batteries. Photographic light meters, as well as electronic gadgets like real-time appliance clocks, can benefit from mercury batteries.

Importance of Battery

The importance of batteries are – Batteries serve as a backup supply of electricity in telecommunications, public transportation, and medical treatments, as well as delivering the initial power required to start automotive engines. By efficiently storing electricity supplied by both conventional and renewable energy sources and serving as a power source for electric vehicles, batteries can help cut greenhouse gas emissions

III. THE IMPERATIVE FOR MULTI-FUNCTIONAL GRID-INTERACTIVE CONVERTERS IN RENEWABLE ENERGY INTEGRATION

The integration of renewable energy sources into the existing power grid is an indispensable aspect of the global transition toward a sustainable and resilient energy future. Central to this integration is the role played by grid-interactive converters, particularly those equipped with multi-functional capabilities. This section of the thesis explores the pressing need for multi-functional grid-interactive converters, shedding light on their pivotal role in addressing the intricacies and challenges associated with renewable energy integration.

A multi-functional grid-interactive converter goes beyond the conventional role of a converter that facilitates the connection of renewable energy systems to the grid. It encompasses a range of capabilities that enhance its versatility and adaptability in diverse energy scenarios. The primary functions include bidirectional power flow, energy storage integration, grid support services, and the ability to seamlessly operate in tandem with the grid's dynamic requirements.

A. The Uniqueness of Multi-Functional Converters

1. Bidirectional Power Flow



Unlike traditional converters, multi-functional grid-interactive converters enable bidirectional power flow. This bidirectional capability allows them not only to feed surplus energy into the grid but also to draw power from the grid when needed. This bidirectional functionality is paramount in scenarios where energy demands fluctuate, ensuring an efficient exchange between renewable energy systems and the grid.

2. Energy Storage Integration

A distinguishing feature of multi-functional converters is their integration with energy storage systems. This includes the incorporation of battery banks, enabling the storage of excess energy during periods of high renewable energy generation. The stored energy can then be utilized during periods of low renewable energy output or when grid conditions deviate from specified parameters, providing a reliable backup power source.

3. Grid Support Services

Multi-functional converters contribute to grid stability and reliability by providing ancillary services. These services include frequency regulation, voltage control, and grid synchronization. By actively participating in grid support functions, these converters enhance the overall stability of the power grid, accommodating the intermittent nature of renewable energy sources.

4. Dynamic Grid Synchronization:

Adaptability is a key attribute of multi-functional converters. They synchronize dynamically with the grid, adjusting their operations to align with varying grid conditions. This flexibility is crucial in maintaining a harmonious interaction between renewable energy systems and the grid, ensuring seamless integration without compromising grid stability.

B. The Need for Multi-Functionality in Renewable Energy Integration

1. Mitigating Intermittency Challenges:

Renewable energy sources, such as solar and wind, are inherently intermittent. Multi-functional converters play a vital role in mitigating the challenges posed by this intermittency. By integrating energy storage and bidirectional power flow capabilities, these converters ensure a continuous and reliable power supply, even during periods of low renewable energy generation.

2. Enhancing Grid Resilience: The incorporation of energy storage in multi-functional converters contributes significantly to grid resilience. In the event of grid failures or deviations from prescribed voltage and frequency levels, the stored energy can be utilized to provide backup power, ensuring uninterrupted electricity supply to critical loads.

3. Optimizing Energy Harvesting: Multi-functional converters optimize energy harvesting from renewable sources. The bidirectional power flow allows for efficient utilization of surplus energy by feeding it into the grid, while the integration with energy storage ensures that no excess energy goes to waste. This optimization is integral to maximizing the economic viability and sustainability of renewable energy systems.

4. Grid-Friendly Operation: The dynamic synchronization and grid support services offered by multi-functional converters make them inherently grid-friendly. They operate in harmony with the grid's requirements, contributing to stable frequency and voltage levels. This grid-friendly operation is crucial for preventing disruptions and ensuring the overall reliability of the power grid.

C. Challenges and Considerations

While the benefits of multi-functional grid-interactive converters are evident, it is essential to address associated challenges. These may include the complexity of control algorithms, the need for standardized communication protocols, and considerations related to system interoperability. The thesis will delve deeper into these challenges, providing insights into potential solutions and avenues for further research.

Addressing Challenges in Distributed Generation with Multifunctional Inverters, Distributed Generation (DG) sources, by nature, exhibit intermittency, rendering conventional converters inactive when DG sources are unavailable. This results in the underutilization of converter ratings. On the flip side, the incorporation of power electronic loads into the distribution system and extensive DG system penetration can lead to adverse effects such as harmonic distortions and unbalanced faults [4][5][6]. In markets that prioritize power quality, the consequences of poor power quality become evident through price fluctuations, especially when DG units supply power to sensitive and critical loads [7]. To tackle these challenges; the installation of Multifunctional Inverters (MFI) emerges as a strategic solution. These inverters play a dual role: exporting power available at DG sources and concurrently enhancing power quality using the same MFI [8][9].

IV. OVERCOMING INTERMITTENCY CHALLENGES

1. Utilization Enhancement:

The intermittency of DG sources can result in the inactivity of conventional converters. However, the multi-functionality of MFIs ensures that even during non-availability of DG sources, the inverter remains operational, effectively utilizing its full rating. This adaptability enhances the overall efficiency of power conversion processes.

2. Continuous Operation:



MFIs, unlike traditional converters, are designed to operate continuously, irrespective of the intermittent nature of DG sources. This seamless operation ensures a constant power supply, addressing the challenge posed by the sporadic availability of renewable energy.

Mitigating Undesirable Effects

1. Harmonic Distortion Control: The infiltration of power electronic loads often leads to harmonic distortions in the distribution system. MFIs are equipped with advanced control algorithms that effectively mitigate harmonic distortions, ensuring a cleaner and more stable power output.

2. Fault Management: Unbalanced faults in the system can be disruptive. MFIs, through their multifunctional capabilities, actively manage unbalanced faults, contributing to grid stability and reliability. Their ability to adapt to changing system conditions aids in preventing and addressing potential faults.

A. Ensuring Power Quality in Conscious Markets

1. Enhanced Power Quality: In power quality-conscious markets, the price of electricity is intricately linked to the

quality of power supplied. The installation of MFIs addresses this concern by actively improving power quality. These inverters not only export power from DG sources but also enhance the quality of the exported power, ensuring a stable and high-quality supply to delicate and critical loads.

2. Dynamic Response to Grid Conditions: MFIs exhibit a dynamic response to grid conditions, adapting swiftly to changes in power demand and DG availability. This adaptability ensures that power quality remains consistent even in scenarios where DG units are supplying power to critical loads, minimizing disruptions and fluctuations.

IV. CONCLUSION

A battery is a device that is used to convert chemical energy into electrical energy. Batteries are used in all types of electrical and electronic devices. There are two types of batteries namely, primary and secondary batteries. Primary batteries are single-use or non-rechargeable batteries.

Primary batteries are again classified into alkaline batteries and coin cell batteries. Secondary batteries are rechargeable or reusable batteries. Secondary batteries are again classified into Lead – Acid Batteries, Nickel – Cadmium Batteries, Nickel – Metal Hydride Batteries and Lithium-Ion Batteries.

1) The potential market for EES in the future is much larger than the existing market, mainly driven by the extended use of renewable energy sources and the transformation of the energy sector, including new applications such as electric mobility. The market volume is related to the (future) renewable energy ratio and varies among regions. 2) If further cost reductions and

technology improvement can be achieved, EES systems will be widely deployed, for example, to shift the demand, smooth renewable energy output and improve the efficiency of existing power generation. 3) European studies indicate huge expectations for EES technologies to compensate for the fluctuation of renewable energy power output. Large installations of wind turbines and Pvs may require numerous EES systems, capable of discharging electricity for periods from two hours up to one day. Hence the market for conventional large-scale EES is attractive. 4) The extensive introduction of electrochemical EES such as NaS, Li-ion and RFB in the MW -MWh range is expected, for discharge times of hours to days. 5) Long-term energy storage is essential to achieving very high renewable energy ratios. The IEA report shows that further installation of renewable energy will lead to an insufficiency of thermal power generators for power control, and cause short-time output fluctuations. This scenario may be expected in Western Europe and China which have both set high renewable-energy-penetration targets. 6) To cover longer discharge times of days to months hydrogen and SNG technology have to be developed. The well established natural gas grid and underground storage in regions such as Europe can be (partly) used for H₂ and SNG storage. 7) Smart Grid technology using many small, dispersed batteries, such as EV batteries, is attractive for many applications. But even if all EV

batteries are used for this purpose they will be insufficient to cover future demand for EES

REFERENCE

- [1] B. Corona, M. Nakano, H. Pérez, "Adaptive Watermarking Algorithm for Binary Image Watermarks", *Lecture Notes in Computer Science, Springer, pp. 207-215, 2004.*
- [2] A. A. Reddy and B. N. Chatterji, "A new wavelet based logo-watermarking scheme," *Pattern Recognition Letters*, vol. 26, pp. 1019-1027, 2005.
- [3] P. S. Huang, C. S. Chiang, C. P. Chang, and T. M. Tu, "Robust spatial watermarking technique for colour images via direct saturation adjustment," *Vision, Image and Signal Processing, IEE Proceedings -*, vol. 152, pp. 561-574, 2005.
- [4] F. Gonzalez and J. Hernandez, "A tutorial on Digital Watermarking", In *IEEE annual Carnahan conference on security technology*, Spain, 1999.
- [5] D. Kunder, "Multi-resolution Digital Watermarking Algorithms and Implications for Multimedia Signals", Ph.D. thesis, university of Toronto, Canada, 2001.
- [6] J. Eggers, J. Su and B. Girod, "Robustness of a Blind Image Watermarking Scheme", *Proc. IEEE Int. Conf. on Image Proc.*, Vancouver, 2000.



- [7] Barni M., Bartolini F., Piva A., Multichannel watermarking of color images, *IEEE Transaction on Circuits and Systems of Video Technology* 12(3) (2002) 142-156.
- [8] Kundur D., Hatzinakos D., Towards robust logo watermarking using multiresolution image fusion, *IEEE Transactions on Multimedia* 6 (2004) 185-197.
- [9] C.S. Lu, H.Y.M Liao, "Multipurpose watermarking for image authentication and protection," *IEEE Transaction on Image Processing*, vol. 10, pp. 1579-1592, Oct. 2001.
- [10] L. Ghouti, A. Bouridane, M.K. Ibrahim, and S. Boussakta, "Digital image watermarking using balanced multiwavelets", *IEEE Trans. Signal Process.*, 2006, Vol. 54, No. 4, pp. 1519-1536.
- [11] P. Tay and J. Havlicek, "Image Watermarking Using Wavelets", in *Proceedings of the 2002 IEEE*, pp. II.258 – II.261, 2002.
- [12] P. Kumswat, Ki. Attakitmongcol and A. Striaew, "A New Approach for Optimization in Image Watermarking by Using Genetic Algorithms", *IEEE Transactions on Signal Processing*, Vol. 53, No. 12, pp. 4707-4719, December, 2005.
- [13] H. Daren, L. Jifuen, H. Jiwu, and L. Hongmei, "A DWT-Based Image Watermarking Algorithm", in *Proceedings of the IEEE International Conference on Multimedia and Expo*, pp. 429-432, 2001.
- [14] C. Hsu and J. Wu, "Multi-resolution Watermarking for Digital Images", *IEEE Transactions on Circuits and Systems- II*, Vol. 45, No. 8, pp. 1097-1101, August 1998.
- [15] R. Mehul, "Discrete Wavelet Transform Based Multiple Watermarking Scheme", in *Proceedings of the 2003 IEEE TENCN*, pp. 935-938, 2003.