

# ENERGY GENERATION SYSTEM USING OSCILLATING WATER COLUMN CONCEPT

Amitpal Singh, Harikrishnan Eramangalath, Lay Patel  
Department of Engineering  
Memorial University of Newfoundland  
St. John's, Canada

**Abstract**— The energy demand is estimated to rise considerably over the following decades. The traditional methods of energy production contribute to serious environmental problems, and all countries worldwide are exploring alternative ways to generate electricity. The ocean waves are a vital renewable energy resource that, if extensively exploited, may contribute significantly to the electrical energy supply of countries with coasts facing the sea. A wide variety of technologies has been proposed, studied, and tested at full size in actual ocean conditions. Oscillating-water-column (OWC) devices of fixed or floating are necessary wave energy devices. In this paper, the waves' energy calculation is being studied. The energy contained in the waves striking at the coast of St. Johns, Canada, is shown as an example. Further, the oscillating water column concept application to extract energy from waves is being examined. Finally, the use of Well's turbine in such an oscillating water column is being studied. The paper summarizes the various equations used to study the oscillating water column and application of well's turbine in such a system. MATLAB model has been used to calculate the turbine flow coefficient, turbine torque and its mean value, turbine power and its mean value. The characteristics obtained as output of the study align with the typical features of a well's turbine.

**Keywords**—Oscillating water column, Wells turbine, Wave energy extraction, MATLAB/Simulink model of Wells turbine.

## I. INTRODUCTION

Many countries have immense coastlines with waves constantly hitting the coast. These waves have vast amounts of energy which is available day and night. Electricity can be generated by installing large-sized water columns next to the coastline (dipped in seawater) where natural elevation is general in the form of small hills or cliffs, as shown in Figure (1). The movement of waves shall result in the upward and downward trend of water inside the water columns resulting in an oscillating water column. The oscillating water column results in compression and suction of air trapped inside the tube. This moving air can pass through a Wells turbine to rotate and generate electricity.

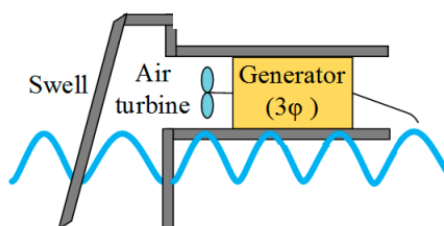

Figure 1: Basic layout of the Wells turbine system

The oscillating mass of water inside the water column has potential energy and kinetic energy, which gets converted into the kinetic energy in the air caused by the ocean waves. The kinetic energy of the air is transmitted to the rotating turbine blades of the Wells Turbine. Wells turbine is popular for such applications as the wind turbine rotates in a single direction irrespective of the wind flow direction.

## A. Literature review

Energy generation from ocean waves has been explored by many in the past, with few installations in some parts of the world. One such example is the usage of the Limpet system in Wester, Scotland. The Limpet system is an OWC prototype model which uses an oscillating water column system to derive power from the wave. This device has three chambers that, on average, can generate 100 kW of electricity [1]. Similarly, Ocean Power Technology, a United States company, commissioned 150 kW surge energy (WEC) systems in Scotland in 2011 [2]. An Irish company Wavebob tested a one-quarter scale model in Galway Bay, Ireland, in 2006 [3]. In Denmark, the half-scale 600 kilowatts. Wave Star energy system was stationed at Hanstholm in 2009 [4], and a quarter and a half size model Wave Dragon was tested at Nissum, Bredning in 2003 [5]. Likewise, transnational associations, similar to the International Energy Agency and the International Electrotechnical Commission, are heavily involved in developing surge energy. Many countries worldwide have tremendous energy resources available in the waves on their coastlines. For example, in India on the west coast, the total annual wave power available is 19.5 gigawatt and on the east coast is around 8.7 gigawatt [5].

## B. Problem Statement

There has been significantly less focus of utilities worldwide to commercially set up wave energy power plants due to the availability of other commercially cheaper renewable energy generation methods. However, much research has taken place regarding using the Wells turbine in an oscillating water column in various demo power plants [6]. There have been few studies on wave energy in the past. However, there is a need to rethink and re-evaluate the energy extraction methods from waves. It is thus required to review the various parameters and equations needed to study the energy contained in the ocean waves, water oscillating column and well's turbine. This paper discusses the working principle of the oscillating water column, the unidirectional characteristics of symmetrical airfoil well's turbine and its velocity vectors resulting in lift and drag force components. The paper aims at calculating the power output by installing a Wells turbine inside the water column, as depicted in Figure

(1). This paper uses a MATLAB model to simulate the various parameters of a well's turbine-based energy generation system using an oscillating water column concept.

The proposed system needs an oscillating water column installed in the seashore line. An oscillating water column is a device that is a partially submerged hollow structure that forms an air chamber within the system along with an opening underwater. As the waves rise and fall, the air trapped within the chamber compresses and expands, allowing the Wells turbine to rotate and generate electricity. The selection of the turbine was mainly based on the point of application. The oscillating water column experiences a bi-directional airflow in synchronization with the waves. The Wells turbine is a low-pressure air turbine that rotates continuously in a single direction independent of the airflow direction. Wells turbine blades feature a symmetrical airfoil shape with its plane of symmetry, so it's perpendicular to the air stream in the plane of rotation Figure (2). This system has two types of states of operation -

- i. Energy generation – For falling wave
- ii. Energy generation – For rising tide

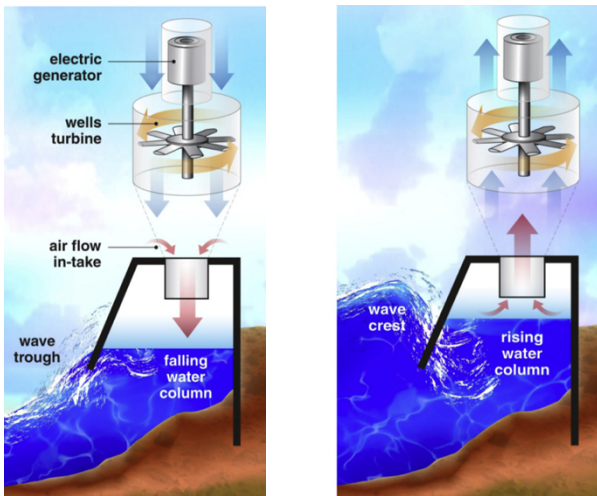

Figure 2: Oscillating water column (Falling and rising wave) - Illustration by Al Hicks, NREL. [8]

### C. Scope of wave energy at St. John's

A detailed study on the wave energy potential of St. Johns, Newfoundland and Labrador – Canada (47.5615° N, 52.7126° W) shows that the proposed location has wave resources, and the development status is as follows –

- Wave energy resource availability  
 Wave energy available in reasonable magnitude 20 to 28 kW/m [7] Figure (3), but in general, lower resource when compared to West coast of Canada 32 to 45 kW/m Figure (4) [6][7].

- Wave energy variation – Seasonal  
 The monthly variation in average wave power for nineteen stations in the Atlantic region is plotted in Figure (5). In the Atlantic region, the mean wave power in winter (December to February) is roughly four to five times larger than the average energy in summer (June to August) [7].

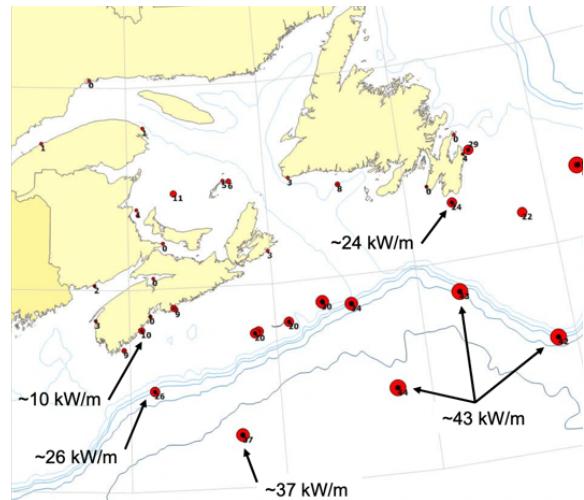

Figure 3: Annual mean wave power for St. John's, Newfoundland [10]

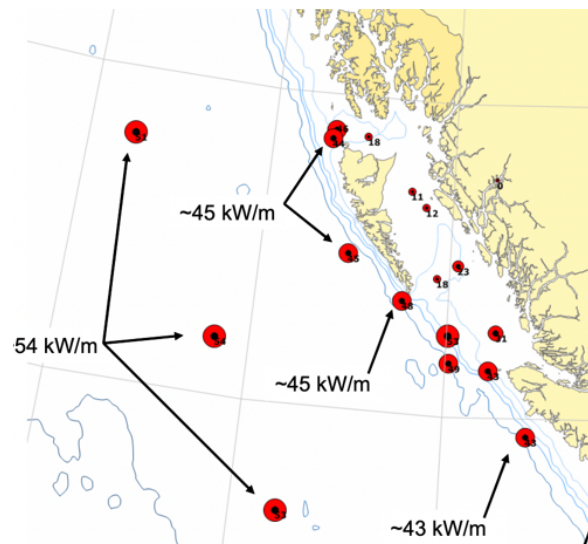

Figure 4: Annual mean wave power for NE Pacific coast [10]

- Wave energy consistency  
 Wave energy plays a less prominent role in the energy sector in St. Johns when compared to hydro, oil and gas, and wind. The energy potential in wave energy is untapped with wood, peat, methane captured from landfills and solar power in some areas.

**D. Turbine used – Wells turbine**

Wells turbine is an axial flow reaction turbine used explicitly for wave energy extraction and operates on the principle of oscillating airflow. Wells turbine is made of symmetric airfoil blade placed around a central hub that constantly rotates in one direction. Irrespective of the airflow direction, the Wells turbine turns in a single order. This feature makes it a favourite for wave energy generation using an oscillating water column system. It has a rotational speed controlled by the blade tip velocity. The Wells turbine is coupled with the electrical generator capable of operating with or without guide vanes. Blades are set at the hub's 90° stagger angle [8]. The absolute velocity of the air that hits the edge axially and the tangential velocity of the blade acts in the direction parallel to the plane of rotation Figure (6). The main disadvantage of a Wells turbine is reduced starting characteristics and its reduced ability to reach its operational speed. This phenomenon of the Wells turbine declining to achieve its operating speed is known as the crawling of the Wells turbine [8]. This is counteracted by improving the hub-to-tip ratio of the Wells turbine.

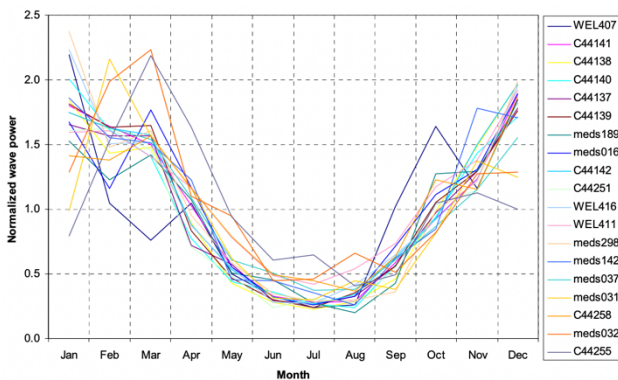

Figure 5: Seasonal variation in average wave energy in the Atlantic coast [10]

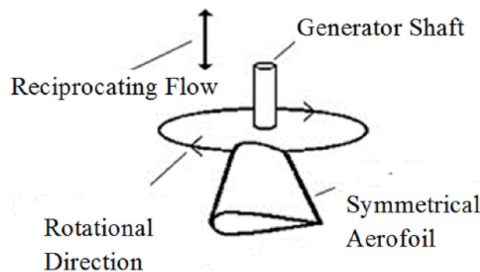

Figure 6: Wells turbine architecture [8]

**II. CALCULATION OF ENERGY AND POWER DENSITY**

Ocean waves are created by wind, storms or other regional winds reaching the coastline, which are swells of water in the shape of waves. Ripples in the simplest form can be represented as shown in Figure (7).

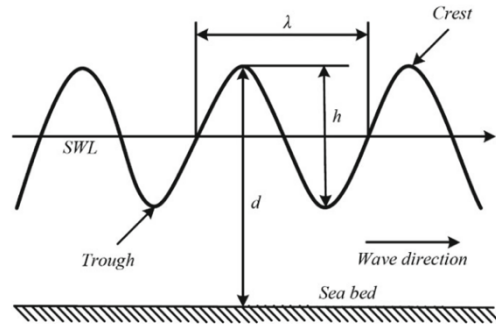

Figure 7: Simple linear shape of ocean wave [8]

In Figure (7), the height of the wave, which is the distance between the crest and trough of a wave,  $\lambda$  is the wave wavelength which can be defined as the distance between two consecutive troughs or crests,  $d$  is the sea depth. It can be defined as the distance between the still seawater surface and the ocean sea bed. The wave's total energy is the kinetic and the potential points [9].

$$TE = PE + KE \tag{1}$$

**A. Total energy (TE) of the wave**

The wave's potential energy is the energy that results from an elevation of the water above the mean level. The potential energy is defined as [9]:

$$PE = \frac{\rho a^2 \lambda L g}{4} \tag{2}$$

Where  $\rho$  is the seawater density (which is 1030 Kg/m<sup>3</sup>),  $a$  is half the height (in m),  $\lambda$  is the wave wavelength (in m),  $L$  equals the arbitrary width of a two-dimensional wave (in m), and  $g$  is the gravitational acceleration.

Hence the potential energy density per unit area =  $\frac{\rho a^2 g}{4}$

The kinetic energy of the ocean wave is the energy of the liquid between the two liquid planes which is perpendicular to the direction of wave propagation and positioned one wavelength apart [9]

$$KE = \frac{\rho a^2 \lambda L g}{4} \tag{3}$$

The kinetic energy density per unit area =  $\frac{\rho a^2 g}{4}$

The total energy can be defined as the sum of potential Eqn. [1] and kinetic energy Eqn. [2]. From the equations, the potential energy and the kinetic energy of ocean waves are

equal. The total energy density is the sum of potential energy per unit area and kinetic energy per unit area.

$$TE/A = \frac{KA + PA}{a} = \frac{\rho a^2 g}{2} \quad (4)$$

The power density (P.D.), which is energy per unit time, is given by:

$$PD/A = \frac{\rho a^2 g f}{2} \quad (5)$$

Where  $f$  is the frequency of the sea wave, which is the reciprocal of wave period,  $\tau$ .

i.e. 
$$PD/A = \frac{\rho a^2 g f}{2\tau} \quad (6)$$

**B. Total energy (TE) calculation for a wave at St. John’s**

Sea wave data for St. John’s has been taken from the website of Smart Atlantic Alliance [10]. A three-meter diameter oceanographic buoy built by AXYS Environmental Technologies of Sidney, British Columbia, is in St. John’s Bay. It is located just north of Cape Spear at the approaches to St. John’s harbour in about 160-meter water deep. St. John’s buoy is located near the coast, as shown in Figure (8).

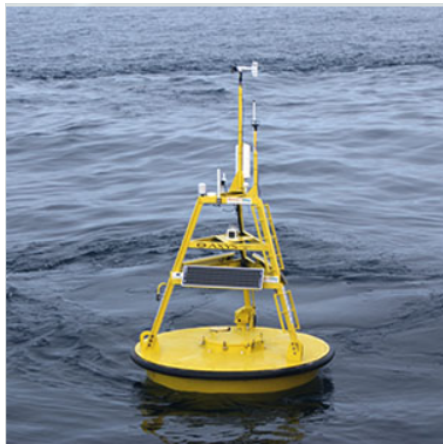

Figure 8: St. John’s buoy - geographical location [10]



Figure 9: St. John’s buoy [10]

The average wave height obtained from the reference [10] comes out to be 1.9 meters for the year 2021; that is,  $h = 1.9\text{m}$ .

The average wave period obtained from the website comes out to be  $\tau = 10.6$  seconds for the year 2021—data provided in Figure (10).

The total energy thus available in the waves can be given by:

$$TE/A \text{ (St John's)} = 0.5 \times 1030 \times (1.9/2)^2 \times 9.8 = 4554 \text{ J/m}^2$$

The power density thus available in the waves can be given by:

$$PD/A \text{ (St John's)} = 0.5 \times 1030 \times (1.9/2)^2 \times 9.8/10.6 = 430 \text{ watts/m}^2$$



station_name	time	air_temp_avg	wave_ht_max	wave_ht_sig	wave_period_max	wave_spread_avg
	UTC	degree_C	m	m	s	degree
smb_st_johns	2021-12-01T00:00:01Z	6.3	4.1	2.3	10.0	40
smb_st_johns	2021-12-01T00:30:01Z	6.2	3.4	2.1	9.1	39
smb_st_johns	2021-12-01T01:00:01Z	5.8	3.6	2.3	9.5	35
smb_st_johns	2021-12-01T01:30:01Z	5.5	4.4	2.4	9.5	37
smb_st_johns	2021-12-01T02:00:01Z	5.1	3.6	2.2	9.1	36
smb_st_johns	2021-12-01T02:30:01Z	4.8	3.4	2.1	9.5	37
smb_st_johns	2021-12-01T03:00:01Z	4.6	3.6	2.1	9.5	37
smb_st_johns	2021-12-01T03:30:01Z	4.6	3.0	1.8	10.0	40
smb_st_johns	2021-12-01T04:00:01Z	4.5	3.0	2.1	9.5	37
smb_st_johns	2021-12-01T04:30:01Z	4.4	2.9	2.1	9.5	36
smb_st_johns	2021-12-01T05:00:01Z	4.5	3.0	2.1	9.5	35
smb_st_johns	2021-12-01T05:30:01Z	4.4	3.0	1.9	9.1	34
smb_st_johns	2021-12-01T06:00:01Z	4.3	3.0	1.8	9.5	37
smb_st_johns	2021-12-01T06:30:01Z	4.5	3.6	1.8	9.1	36

Figure 10: Wave data from smart Atlantic [10]

Thus the wave power density comes out to be  $0.430 \text{ kW/m}^2$  for the location of St. John’s, Newfoundland and Labrador. The average daily solar incidence value of  $240 \text{ watt/m}^2$  exists in the southwestern United States. This value comes out to be  $126 \text{ watt/m}^2$  for St. John’s. Accordingly, the power density of ocean waves is much higher than solar. However, the challenge remains to convert this available energy into electricity through a suitable energy conversion system. Figure (10) depicts the data collection table from Ref. [10].

**C. Oscillating wave column wave energy converter - OWC**

A wide variety of technologies has been studied and, in some cases, tested at full size in actual ocean conditions to convert the energy available in ocean waves to electrical power [11]. Out of these, the most popular is the oscillating wave column energy conversion system. Yoshio Masuda (1925-2009), a Japanese navy officer, may be regarded as the father of modern wave energy technology. He developed a navigation buoy powered by wave energy and an air turbine, later named a floating oscillating wave column. In an OWC wave energy converter, the hydraulic energy of oscillating wave motion is converted to an oscillating air column in a chamber. This bi-directional airflow is converted to mechanical rotation energy by an air turbine indicated in Figure (11).

The incoming waves produce alternating airflow through the turbine duct upon hitting the water column. The following expression will give the airflow velocity if the wave height is presumed to be the same outside and inside the chamber [12].

$$V_x = \frac{A_{owc}}{A_{duct}} \frac{\partial h(t)}{\partial t} \quad (7)$$

Where,  $V_x$  is the air velocity (in m/s),  $A_{owc}$  is cross-sectional chamber area (in  $m^2$ ),  $A_{duct}$  is cross-sectional duct area (in  $m^2$ ),  $h(t)$  is a function of wave amplitude (in m) inside the OWC, and the air losses within the column are ignored.

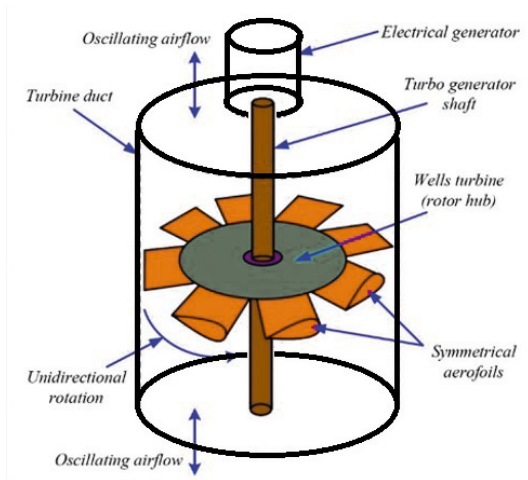

Figure 11: Wells turbine schematic

The expression for differential OWC chamber pressure (Pa) across the turbine duct is given as:

$$dP = \frac{C_a}{K_t} A_{duct} (V_x^2 + (r\omega)^2) \quad (8)$$

Here  $C_a$  is the power coefficient,  $K_t$  is turbine constant (Kg/m),  $V_x$  is airflow speed at the turbine (in m/s),  $\omega$  is turbine rotor speed (in rad/s),  $r$  is the mean radius. The oscillating water column energy equations are similar to those used for wind turbines. The power available from the airflow in the OWC's chamber is given by Eqn. (13). Also, the input wave power available for airflow at the turbine duct is given as [13]:

$$P_{in} = \left( dp + \frac{\rho a V_x^2}{2} \right) V_x A_{duct} \quad (9)$$

Where  $P_{in}$  is the pneumatic incident power (in W),  $dp$  is the pressure at the turbine duct (in Pa),  $\rho$  is the density of air,  $V_x$  is the airflow speed at the turbine (m/s),  $A_{duct}$  is an area of the turbine duct. So, the OWC chamber pressure is the input to the Wells turbine.

#### D. Wells turbine

The Wells turbine is a low-pressure air turbine that rotates continuously in the same direction regardless of the airflow direction. In its simplest form, the Wells turbine rotor consists of several symmetrical airfoil blades positioned around a hub with their chord planes normal to the axis of rotation Figure (11). According to the airfoil theory, an airfoil set at an angle of incidence,  $\alpha$ , in a fluid flow, generates a lift force,  $L$ , perpendicular to the free stream. The airfoil experiences a drag force  $D$ , in the direction of the free stream (relative velocity) Figure (12), Figure (13). These lift and drag forces can be resolved into tangential (in the plane of rotation) and axial (normal to the plane of rotation) components  $F_\theta$  and  $F_x$ , respectively.

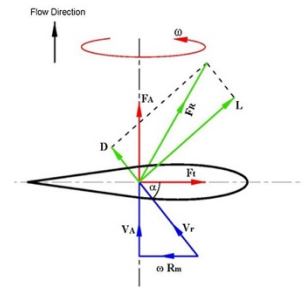

Figure 12: Wells turbine vector chart for flow in an upward direction

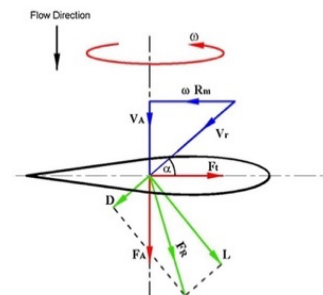

Figure 13: Wells turbine vector chart for flow in a downward direction

The Wells turbine is subjected to bi-directional airflow. The airflow incidence angle switches signs depending on the direction of flow. If  $\alpha$  can be regarded as positive when the airflow is in one order, it is negative in the opposite direction. For a symmetrical airfoil, the focus of tangential force  $F_\theta$  is the same for both positive and negative values of  $\alpha$ . If airfoil blades are arranged around the axis of rotation, they will constantly rotate in a single direction regardless of airflow direction. Therefore the turbine does not need resolving valves in a bi-directional airflow. Because of this distinctive feature, the Wells turbine is well suited for wave energy conversion from devices based on the oscillating water column principle.

At lower flow rates (at small airflow incidence scenarios), the vector component of drag in the chord direction is much more significant than the lift component. Therefore, the efficiencies are always negative. At such incidences, the pneumatic power input is disintegrated as heat and hence there is no power output. Also, the Wells turbine, unlike

conventional turbines, does not act as a pump under these conditions. A significant flow rates (large incidence scenarios), the blade's boundary layer separates (stall), leading to a drop in efficiency. In a bi-directional or random airflow, the turbine blades will experience a time-varying torque which can be compensated by a high inertia flywheel or rotor [14]. For any given turbine speed, if the variation of airflow speed with time is sinusoidal, the power lost because of energy dissipation by the turbine for minor incidences forms only a tiny part of time-averaged power output. The input to the Wells turbine is the alternating pressure drop across the turbine rotor, which is generated due to the airflow from the OWC chamber. The equations for the Wells turbine are indicated below [14].

The pressure drop across the turbine can be expressed as:

$$dP = \frac{C_a}{K_t} A_{duct} (V_x^2 + (r\omega)^2) \quad (10)$$

The torque produced by the turbine can be expressed as:

$$T_t = C_t k_t r [V_x^2 + (r\omega)^2] \quad (11)$$

$$T_t = dP C_t (C_a)^{-1} r (A_{duct}) \quad (12)$$

The Wells turbine flow coefficient, which can be expressed as the angle, is given as:

$$\varphi = \frac{V_x}{\omega r} \quad (13)$$

$k_t$  is the turbine constant and is expressed as:

$$k_t = 0.5b \rho_{ab} b_{tb} n_t l_t \quad (14)$$

The expression gives Wells turbine output power:

$$P_t = T_t \omega_r \quad (15)$$

Finally, the Wells turbine efficiency is represented as:

$$\eta_t = \frac{T_t \omega_r}{dP Q_x} = \frac{C_t}{\omega C_a} \quad (16)$$

$$Q_x = V_x A_{duct} \quad (17)$$

Where  $Q_x$  is the airflow rate (in  $m^3/s$ ),  $C_a$  is the power coefficient,  $K_t$  is turbine constant ( $Kg/m$ ),  $V_x$  is airflow speed at the turbine (in  $m/s$ ),  $\omega_r$  is turbine rotor speed (in  $rad/s$ ),  $R$  is the mean radius,  $T_t$  is the torque produced by the turbine (in  $Nm$ ),  $C_t$  is the torque coefficient,  $\rho_a$  is the air density in  $Kg/m^3$ ,  $b_t$  is blade height (in  $m$ ),  $n_t$  is the number of blades,  $l_t$  is the blade chord length (in  $m$ ),  $\varphi$  is Wells turbine flow coefficient (expressed in angle),  $\eta_t$  is the efficiency of the turbine and  $A_{duct}$  is an area of the turbine duct.

Equation [15],  $P_t$  suggests that the performance of the Wells turbine depends on the coefficients of power, torque and flow. Variation of the coefficient of power and the coefficient of torque against the flow coefficient for the typical Wells turbine is shown in Figure [14] and Figure [15]. From the equation [13] of the flow coefficient, it can be seen that the flow coefficient is directly proportional to the airflow velocity.

As the rate of airflow increases, the flow coefficient also increases, resulting in a higher torque coefficient ( $C_t$ ). This rise, however, is limited to a critical flow coefficient of 0.3 [15-16], which is seen in the curve of torque coefficient vs flow coefficient. The turbine efficiency subsequently drops due to the stalling effect.

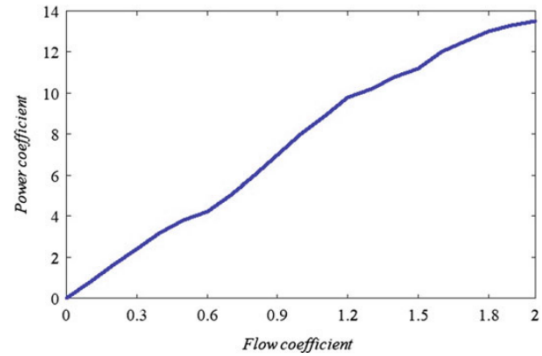

Figure 14: Power coefficient versus flow coefficient for Wells turbine [8]

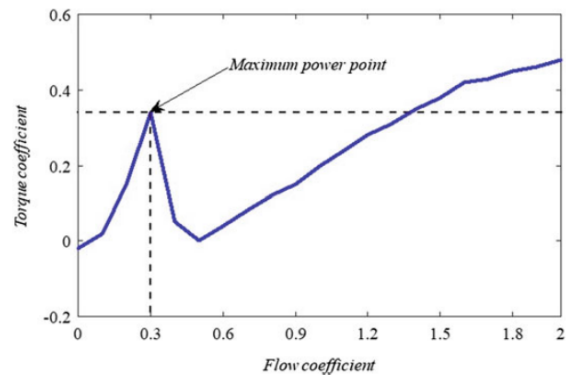

Figure 15: Torque coefficient versus flow coefficient for Wells turbine [8]

### III. MATLAB AND STEADY-STATE MODELLING

The MATLAB/Simulink diagram of the Wells turbine and is shown in Figure [16]. The MATLAB model has three input parameters: differential pressure, rotor speed, and control input to control differential pressure in the turbine duct. The output variables include turbine flow coefficient, torque, turbine power and its mean value. The nonlinear characteristics of the Wells turbine in Figure [17] have been designed using Simulink. This presents the numerical simulations of the open-loop OWC plant to identify the control problems associated with OWC plants. Eight parameters were used for modelling the OWC in MATLAB/Simulink. The open-loop/uncontrolled OWC model is simulated for 50 s with normal pressure conditions. The MATLAB/Simulink diagram of the overall OWC plant without any control scheme is shown in Figure (16). In Figure (16), the following data was taken for simulation of the MATLAB/Simulink OWC plant.

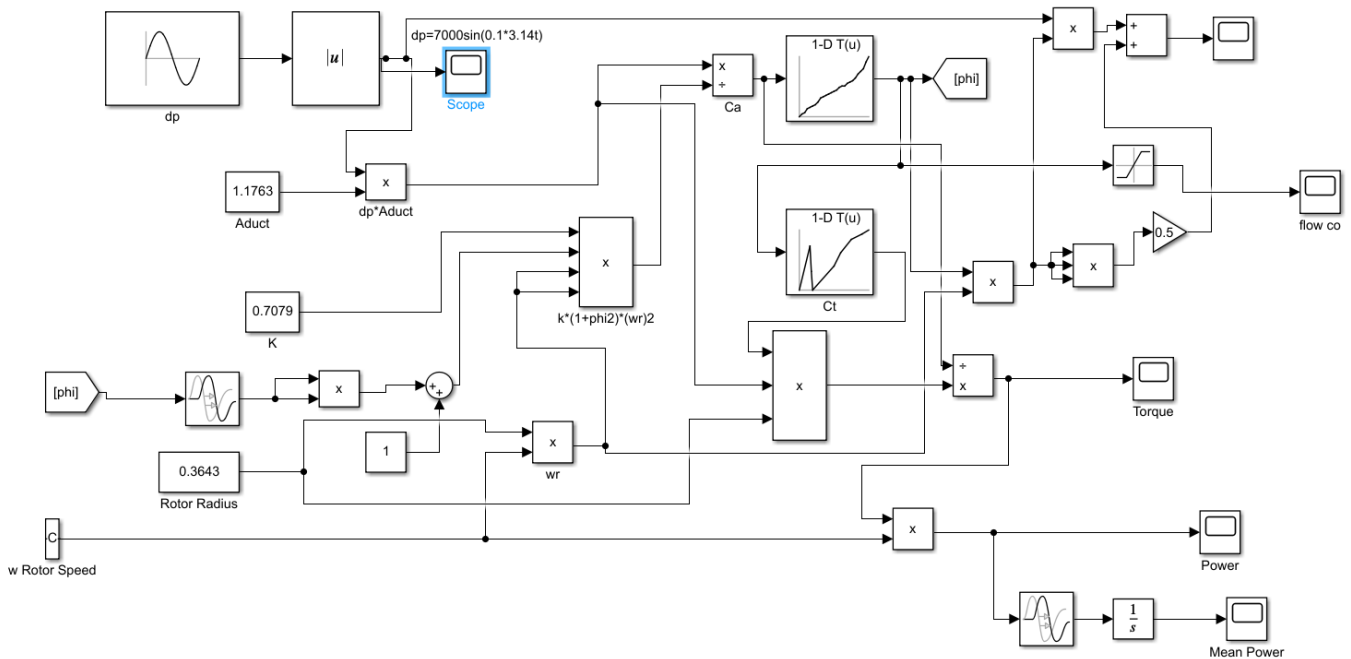

Figure 16: MATLAB simulation of OWC plant

1. OWC Chamber
  - $A_{owc} = 7.5 \text{ m}^2$
  - $A_{duct} = 1.1763 \text{ m}^2$
2. Wells Turbine
  - $K_t = 0.7079$
  - $r = 0.3643$
  - $B_t = 0.4$
  - $L_t = 0.38$
  - $F = 0.02$
  - $J = 50$

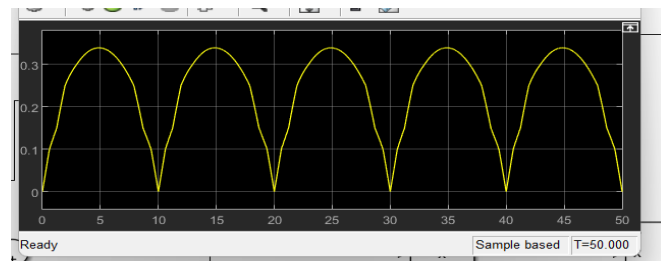

Figure 18: Flow coefficient versus Time at Pmax set to 7000

For normal sea wave conditions, the turbine duct pressure difference is considered as [15]:

$$dp = |7000 \sin(0.1 \pi t)| \text{ Pa}$$

And is shown in Figure (17), where normal wave conditions are illustrated. After running the MATLAB simulation for 50 s, the time-varying waveforms of OWC plant parameters are obtained, including turbine flow coefficient and turbine power. It is observed that for

$$dp = |7000 \sin(0.1 \pi t)| \text{ Pa}$$

turbine flow coefficient breaches the limit of 0.3; Figure (18).

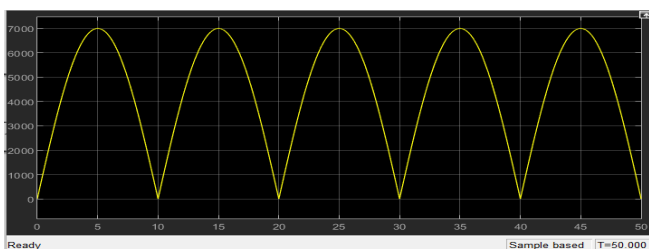

Figure 17: dp versus Time at Pmax set to 7000

In steady-state, it is observed that the system under study oscillates to a maximum value of 0.34, which is above 0.3, corresponding to the stalling behaviour threshold value for the turbine. That's why the power to produce will be limited, as shown in Figure (19).



Figure 19: Turbine power versus Time at Pmax set to 7000

The value of mean turbine power is obtained as 25.42 kW; Figure (19).

#### A. Performance Evaluation through Energy Efficiency

Ocean waves can be highly unexpected, causing huge power fluctuations at the generator output, which are not

appropriate for the grid. Another difficulty is that during strong transient power inputs from the sea waves, the efficiency of the energy conversion process drops dramatically. In hydropower facilities, water intake can be precisely controlled through the control system by opening and closing guiding vanes. As a result, the power output and efficiency may be maintained. However, in a wave energy conversion system, there is no direct control over the passage of sea waves, making it impossible to sustain power and hence efficiency. As a result, an indirect method of managing the turbine's energy input must be established. The Wells turbine efficiency, as stated earlier in the text, is expressed as follows in equation 16. As a result, the efficiency is determined by the OWC chamber pressure difference ( $dP$ ) across the turbine duct. The turbine's efficiency could be controlled by adjusting the differential pressure. Controlling the differential pressure across the well's turbine can regulate the efficiency of the well's turbine even if no control over sea waves is available. SIMULINK was used to simulate the relationship between efficiency and turbine output to comprehend it better. A regular wave scenario has been investigated in this paper's simulation, with differential pressure  $dP = 7000 \sin(0.1 \pi t)$  for 50 seconds. A stalling effect is observed for all extreme amounts of energy input from the sea waves, represented by high differential pressure values (up to 7000). The turbine's power production reduces dramatically at specific stall locations, significantly lowering the OWC plant's efficiency. MATLAB has been used to simulate a time-varying irregular sea wave condition, as shown in Figure (20):

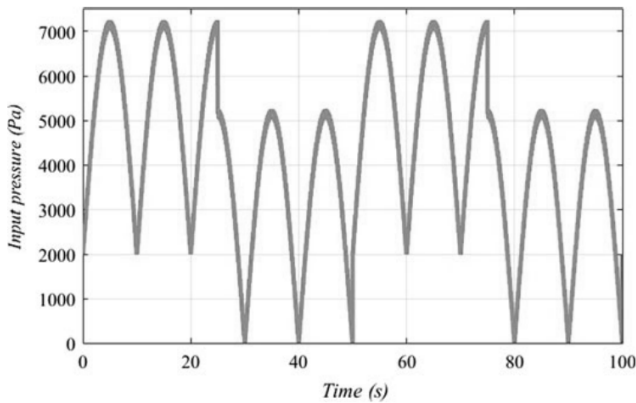

Figure 20: Irregular wave conditions [17]

The stall phenomena are visible for each value of  $dP$  greater than 5000, whereas the turbine can operate stall-free for each value of  $dP$  less than 5000. As a result, as the value of  $dP$  grows from 5000 to 7000, the flow coefficient rises, and the turbine power reaches its maximum value, as seen in Table (1). The table shows that the turbine's output reaches its maximum when  $dP$  is 7000. Any increase in differential pressure above this point causes the turbine to stall, reducing the energy output and, as a result, the turbine's efficiency.

TABLE 1. CHANGE IN FLOW COEFFICIENT

$P_{max}$ (Pa)	$\phi$	$P_g$ (kW)
5000	0-0.276	-22.10 kW
5500	0-0.292	-23.86 kW
6000	0-0.331	-25.06 kW
6500	0-0.332	-24.36 kW
7000	0-0.338	-25.42 kW
7500	0-0.353	-21.04 kW
8000	0-0.367	-19.25 kW
8500	0-0.389	-17.27 kW
9000	0-0.396	-15.40 kW

For each value of  $dP$  larger than 5000, the stall phenomenon is observable, however for each value of  $dP$  less than 5000, the turbine can function without stalling as shown in Figure (21).

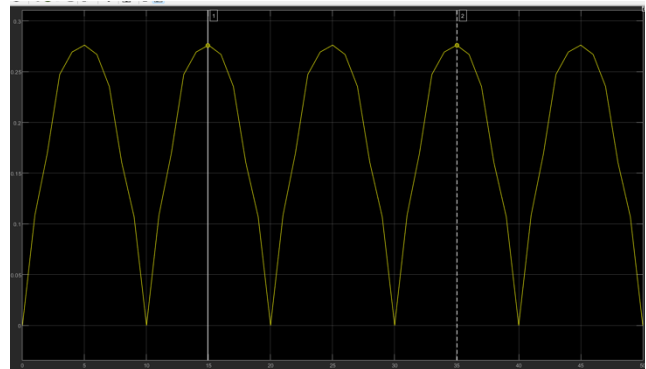

Figure 21: Turbine power versus Time at  $P_{max}$  set to 5000



Figure 22: Flow coefficient versus Time at  $P_{max}$  set to 5000

Any rise in differential pressure over this limit causes the turbine to stall, lowering the turbine's energy production and efficiency. As seen from Figure (24), when the maximum pressure is 9000, the stalling phenomenon is prominent, and



the energy output is 15.40 kW. That is a fall of 40 percent in peak energy production.

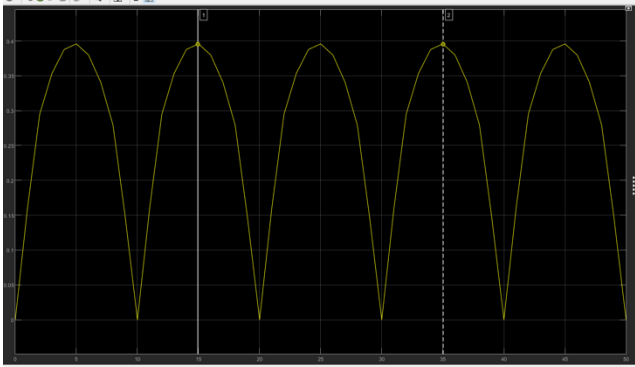

Figure 23: Turbine power versus Time at Pmax set to 9000



Figure 24: Flow coefficient versus Time at Pmax set to 9000

According to the simulations above, the critical problem in achieving maximum efficiency in an OWC Wells turbine energy generating system is "controlling the stall effect." An airflow control approach in the form of "air control valves" can be used to adjust the differential pressure. The air control valves could bypass the extra pressure causing the stall whenever there is a transient spike in energy input from the sea waves [16-17]. The bypass valves aid in limiting the turbine's access energy input. To create the most power, the turbine must be able to rotate freely without stalling. Figure (25) shows that a controller controls the air valve.

Controlling the rotational speed  $\omega_r$  is another option to influence efficiency. Power electronics are utilized to regulate the generator side of the OWC plant to control the rotating speed. In the case of a doubly-fed induction generator, a back-to-back AC to DC to AC converter can be utilized in the rotor circuit, as shown in the diagram above. The current supply to the generator's rotor may thus be modified by altering the firing angle of the power electronics, resulting in variable speed control of the generator. This speed control may aid in operating the OWC turbine in the non-stalling region, hence increasing its efficiency [16-18].

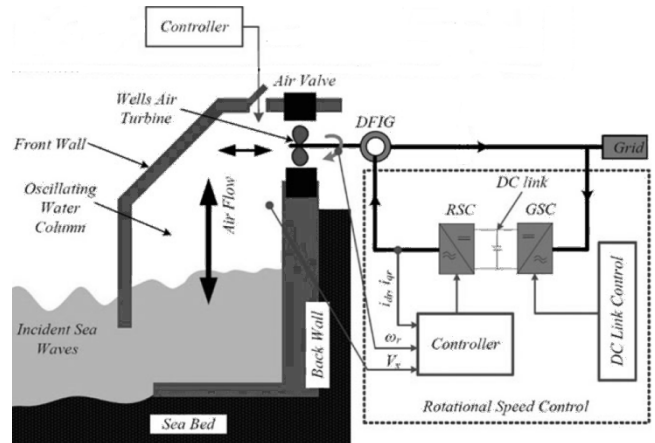

Figure 25: System controller [18]

### B. Financial Viability

The primary impediment to the expansion of wave energy-producing systems is the energy source itself, which is the sea. The peak-to-average load ratio, which is likewise relatively high, is tough to estimate. Unlike a hydropower facility, where water levels can be predicted for 100 years, it is tough to precisely anticipate the 50-year return time for wave energy facilities at a specific location. As a result, there is always the risk of underestimating or overestimating a device's design loads. Underestimation might result in the complete or partial loss of facilities.

On the other hand, overestimation can lead to high construction costs, which in turn lead to high generation costs, making the technology uncompetitive when compared to other renewable energy sources. These obstacles, combined with the industry's lack of understanding of wave technology, have hindered wave energy development. As a result, current designs, and concepts, such as the oscillating water column, are not currently competitive or financially viable compared to alternative energy sources. However, because sea waves are a plentiful resource with large energy flux, proper design and implementation can make designs more efficient, and thus energy generation can become financially viable.

Furthermore, the environmental impact is small, and the natural seasonal variability of sea wave energy matches the electricity demand in temperate temperature regions. Another commercially viable application is synchronous generators for reactive power regulation. Compared to other energy sources that require ample space, the lack of demand for land is crucial in determining energy generation economics. When paired with the current development of offshore wind energy systems, wave energy can be cost-effective by sharing conventional offshore substations or high-voltage equipment. Due to the corrosive marine environment, harsh weather conditions, and randomness in input power, complex designs are required. The transient load in the water may be several



thousands of times higher than the rated values, making it impossible to estimate. As a result, to account for this, designers create OWC turbines with a significantly higher degree of safety margin, which renders the design less cost-effective.

#### IV. ENVIRONMENTAL SCOPE AND SUSTAINABILITY

Wave Energy is thought to be a non-polluting, renewable energy source. Furthermore, wave energy devices may not emit greenhouse gas pollutants and emissions associated with burning fossil fuels to generate power, such as carbon dioxide and nitrogen oxides. However, the environmental impact of wave energy on the nearby area must also be considered. However, whether renewable or conventional, all forms of electrical generation have an ecological impact.

Wave Energy is a sustainable and clean energy source that can replenish itself naturally over a short period and has less environmental impact than some other forms of renewable power generation. The power density of ocean waves is much higher than solar. Unlike solar resources, wave energy is available even during the night. Some of the environmental effects of wave energy may be beneficial, while some others could be potentially harmful. However, little is known now about the potential environmental impact of wave energy devices and other ocean-based technologies because many are still in their experimental or early stages of deployment. Hence there is very little information on the same. Wave energy schemes are built to reference ocean-based oil drilling platforms and offshore wind power industries. Because wave energy generation occurs on the ocean's surface, the shoreline, the near-shore line has possible environmental effects of wave energy generation are like those of offshore wind power generation plants. The most common environmental impacts on energy extraction from wave energy are –

- Coastal Erosion
- Fishing Industry
- Marine Eco-system
- Navigational Hazards
- Noise Pollution
- Restriction in Recreational
- Sedimentary Flow

Then, combining ocean wave energy and ocean-designed equipment to generate electricity is a potential prospect and another option to assist lessen our present reliance on non-renewable energy supplies. However, technological obstacles and a lack of understanding of the environmental impacts of wave energy in comparison to other traditional energy sources must be addressed. Some of the above-mentioned ecological consequences will be reduced for floating offshore devices while increasing for near- and shore-based devices. There are several advantages to developing wave energy and ocean-based technologies. Emissions-free electricity is, of course, the principal

advantage, but another significant advantage is energy security. Still, there is not much energy at any given location. The development of wave energy and ocean-based technologies has many benefits. Of course, emissions-free electricity is the primary benefit, but energy security is also significant. Like other forms of energy, wave energy has environmental and economic repercussions that must be considered when constructing a new installation. Lessons acquired from offshore oil production, wind power, and other ocean-based businesses can help design wave energy systems with lower environmental impact.

#### V. CONCLUSION

A comprehensive review of the various parameters and equations required to study the energy contained in the ocean waves, oscillating water column and well's turbine are presented in the paper and are simulated in a MATLAB model. The report also discusses the working principle of the oscillating water column, the unidirectional characteristics of symmetrical airfoil well's turbine and its velocity vectors resulting in lift and drag force components. The paper presents the equations for the energy contained in sea waves, the velocity of air across the well's turbine due to the movement of waves in the oscillating water column, oscillating differential pressure created across the well's turbine, Pneumatic incident power available for airflow at the turbine duct, torque produced by the well's turbine, Wells turbine flow coefficient and Wells turbine output power. The power coefficient varies linearly with the flow coefficient in the MATLAB output. The torque was also seen to increase with increasing flow coefficient. However, it can be seen that there is a limit to increasing the turbine output with airflow rate as the turbine output falls considerably with a further increase in airflow velocity due to stalling phenomenon. The stalling phenomenon can also be seen from the power output characteristics obtained from the MATLAB output. It is thus recommended that to avoid the stalling phenomenon suitable control mechanism must be adopted for an airflow control approach in the form of air control valves to adjust the differential pressure & bypass the extra energy being supplied by the spikes in sea waves or by regulating the rotor speed through power electronics at the rotor side in case of a doubly-fed induction generator.

#### VI. ACKNOWLEDGEMENT

We express our deep gratitude to Dr. Kevin Pope (Professor, Memorial University of Newfoundland and Labrador, St. John's Canada) for guiding us in completing the project.

#### REFERENCES

- [1] Coleman, Ross A., et al. "A continental-scale evaluation of the role of limpet grazing on rocky shores." *Oecologia* 147.3 (2006): 556-564.
- [2] Ocean Power Technologies; 2011, May [Online]. <http://www.oceanpowertech.com>.
- [3] Wavebob; 2011, May [Online]. <http://www.wavebob.com/home/>.



- [4] Wavestar [Online]. <http://wavestarenergy.com/>.
- [5] Kumar, V.S. and Anoop, T.R., 2015. Wave energy resource assessment for the Indian shelf seas. *Renewable Energy*, 76, pp.212-219.
- [6] Falcão, A. F., & Henriques, J. C. (2016). Oscillating-water-column wave energy converters and air turbines: A review. *Renewable Energy*, 85, 1391-1424.
- [7] Cornett, A. Inventory of Canada's Marine Renewable Energy Resources. Canadian Hydraulics Centre, National Research Council of Canada; April 2006. CHC-TR-041, 2006.
- [8] Das, Tapas Kumar, Paresh Halder, and Abdus Samad. "Optimal design of air turbines for oscillating water column wave energy systems: A review." *The International Journal of Ocean and Climate Systems* 8.1 (2017): 37-49.
- [9] El-Wakil, Mohamed Mohamed. "Powerplant technology." (1984).
- [10] [www.smartatlantic.ca](http://www.smartatlantic.ca)
- [11] Ant3nio, F. O. "Oscillating-water-column wave energy converters and air turbines: A review." *Renewable energy* (2016).
- [12] Ramirez, Dionisio, et al. "Emulation of an OWC ocean energy plant with PMSG and irregular wave model." *IEEE Transactions on Sustainable Energy* 6.4 (2015): 1515-1523.
- [13] Amundarain, Modesto, et al. "Wave energy plants: Control strategies for avoiding the stalling behaviour in the Wells turbine." *Renewable Energy* 35.12 (2010): 2639-2648.
- [14] Amundarain, Modesto, et al. "Wave energy plants: Control strategies for avoiding the stalling behaviour in the Wells turbine." *Renewable Energy* 35.12 (2010): 2639-2648.
- [15] Amundarain, Modesto, et al. "Modeling and simulation of wave energy generation plants: Output power control." *IEEE Transactions on Industrial Electronics* 58.1 (2010): 105-117.
- [16] Henriques, J. C. C., et al. "Latching control of a floating oscillating-water-column wave energy converter." *Renewable Energy* 90 (2016): 229-241.
- [17] Ramirez, Dionisio, et al. "Emulation of an OWC ocean energy plant with PMSG and irregular wave model." *IEEE Transactions on Sustainable Energy* 6.4 (2015): 1515-1523.
- [18] Samrat, Nahidul Hoque, et al. "An off-grid stand-alone wave energy supply system with maximum power extraction scheme for green energy utilization in Malaysian Island." *Desalination and Water Treatment* 57.1 (2016): 58-74.
- [19] Dorrell, David G., and Min-Fu Hsieh. "Performance of Wells turbines for use in small-scale oscillating water columns." *The Eighteenth International Offshore and Polar Engineering Conference*. OnePetro, 2008.